

## High Efficacy LED Series

TSC-A35CM-0103Z3-RGB

VF 2V / 620-625nm

VF 3V / 520-525nm

VF 3V / 460-470nm



### 特性 Features

- 氧化铝陶瓷基板 Alumina ceramic substrate
- 外观尺寸 Package Dimension: 3.5mm×3.5mm×2.35mm
- 发光角度 Viewing Angle: 120°
- 符合ROHS标准 ROHS Approved

### 描述 Description

同一方3535产品具有高光效，高显指，低功耗，发光角度广等一系列特性，这些特性使其成为照明应用的首选。The TYF 3535 package has high efficacy, high Ra, low power consumption, wide viewing angle and a compact form factor. These features make the package an ideal LED for lighting applications

### 应用 Applications

- 室内通用照明 Indoor General Lighting
- 亮化工程 Lighting engineering
- 汽车内部辅助照明 Car interior auxiliary photo
- 工业照明 Industrial lighting
- 线性灯具 Professional downlights
- 替换灯和灯具 Retrofits and fixtures

# 目 录

## Catalogue

1.产品编码	Product Number.....	3
2.外形尺寸	Dimensions.....	3
3.极限参数	Absolute Maximum Ratings.....	4
4.光电特性	Electrical-Optical Characteristics.....	5
5.电压分级	Voltage Grading.....	6
6.典型特性曲线	Typical Characteristic Curves.....	7
7.可靠性试验	Reliability Test Items And Conditions.....	10
8.包装	Packaging.....	11
9.使用注意事项	Caution.....	13

## 1、产品编码 Product Number

1	2	3	-	4	5	6	7	8	-	9	10	11	12	13	14	-	15	16	17	18	19
T	S	C	-	A	3	5	C	M	-	0	1	0	3	Z	1	-	R	G	B	0	1

编码序号 Code No	含义 PKG Information
1-3	产品系列 Range of products
4-8	产品外形 Designates product type
9-12	串并方案 Product specifications Size
13-14	亮度等级 Class of brightness
15-19	颜色代码 Color code

## 2、外形尺寸 Dimensions

单位(Units):毫米(mm)

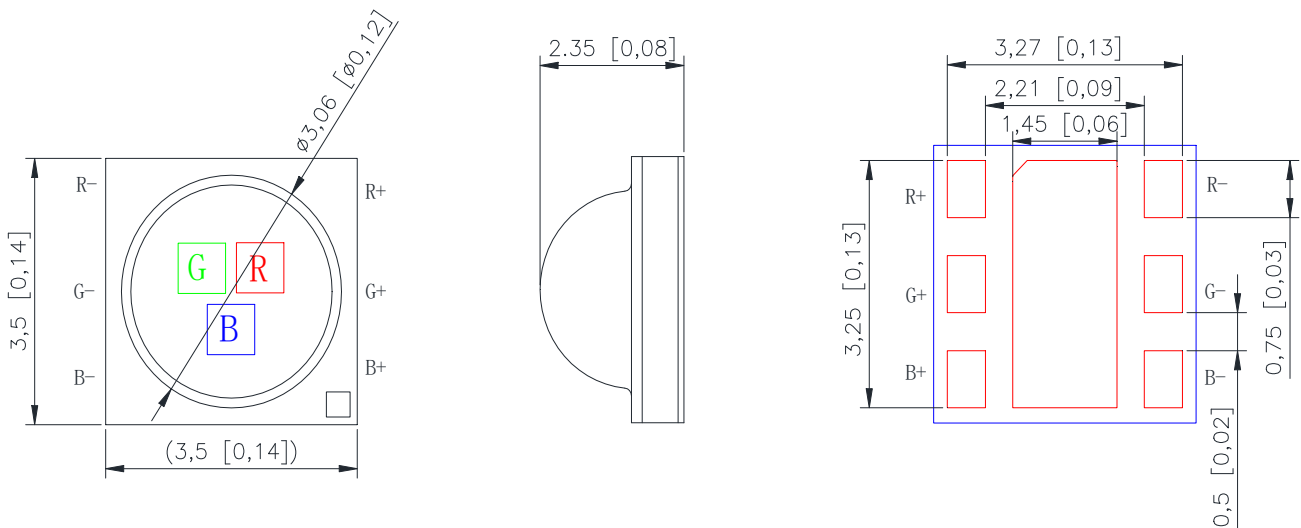

### 备注/Postscript:

所有尺寸单位为 mm ， 如无特殊说明误差范围为 $\pm 0.2$ mm

All dimensions area in mm tolerance is  $\pm 0.2$ mm unless otherwise noted.

### 3、极限参数 Absolute Maximum Ratings

项目 Item	符号 Symbol	数值 Value		单位 Unit
极限功率 Limiting power	P	R	0.40	W
		G	0.45	
		B	0.45	
正向电流 Forward Current	IF	R	≤200	mA
		G	≤150	
		B	≤150	
工作温度 Operating Temperature	Topr	-40° C To +85° C		° C
结点温度 Junction Temperature	Tj	R	115	° C
		G	110	
		B	110	
储存温度 Storage Temperature	Tstg	-40° C To +105° C		° C
静电击穿电压 ESD Sensitivity	ESD	2,000V HBM		V
反向电压 Reverse Voltage	VR	Reverse testing is not allowed		/
反向电流 Reverse Current	IR	VR=5V 1uA		uA
焊接温度 Soldering Temperature	Tsld	260° C/3-5sec.		°C/S
湿度敏感级别 Moisture Sensitivity Rating	MSR	MSL3		°C/RH/H

#### 补充说明 Additional Remarks

·极限功率和正向电流 是指模块温度通过使用合适的散热体下的最大设置数值；

Max power and positive current mean the maximum setting value of the bottom temperature of led light source by using the appropriate heat sink.

·最初连接错误的反向电压，超出将可能损坏模组；

Connection error and off-limits voltage may damage LED chip.

## 4、光电特性 Electrical-Optical characteristics( $T_j = 25^\circ\text{C}$ )

表 1: 在  $T_j=25^\circ\text{C}$  时测试的光电参数

Product	Colour	Wavelength (nm)	Luminous Flux(lm)@150MA	Voltage (V) @150MA	Part Number
TSC-A35CM-0103-RGB	Red	620-625	20-30	1.8-2.2	TSC-A35CM-0103Z3-RGB01-01
	Green	520-525	35-45	2.8-3.2	
	Blue	460-470	5-15	2.8-3.2	

说明:

**表1备注Table 1 note:**

·测试环境温度  $25^\circ\text{C}$ ,若使用不同电流或不同的环境温度测试, 会引起色温及电压的变化;

Testing environment temperature  $25^\circ\text{C}$ , and CCT and voltage will changed if tested in different current and environment temperature.

·不同标准测试仪正常测试允许公差: 电压 $\pm 0.1\text{V}$ , 流明 $\pm 5\%$ , 显指 $\pm 2$ , 色坐标 $\pm 0.005$ ;

Tolerance among different testing machine: Voltage: $\pm 0.1\text{V}$ , Lumen $\pm 5\%$ , CRI $\pm 2$ , Color coordinat  $\pm 0.005$ .

## 5、电压分级 Voltage Grading

3535 led 测试正向电压和分类，正向电压档定义如下：

3535 led test forward voltage and classification, forward voltage file is defined as follows:

Product	Colour	Min VF (V)@ 150MA	Max VF (V)@ 150MA
TSC-A35CM-0103	Red	1.8	2.0
		2.0	2.2
	Green	2.8	3.0
		3.0	3.2
	Blue	2.8	3.0
		3.0	3.2

### 备注/Postscript:

电压分档标准：0.2V/档，光通量分档标准：10LM/档。光通量允许误差±5%。

Voltage classification standard:0.2V/ file, luminous flux classification standard: 10LM/ file.

The allowable error of luminous flux is ±5%.

## 6、典型特性曲线/Typical Characteristic Curves

Relative spectral power distribution (IF=150mA,25°C)

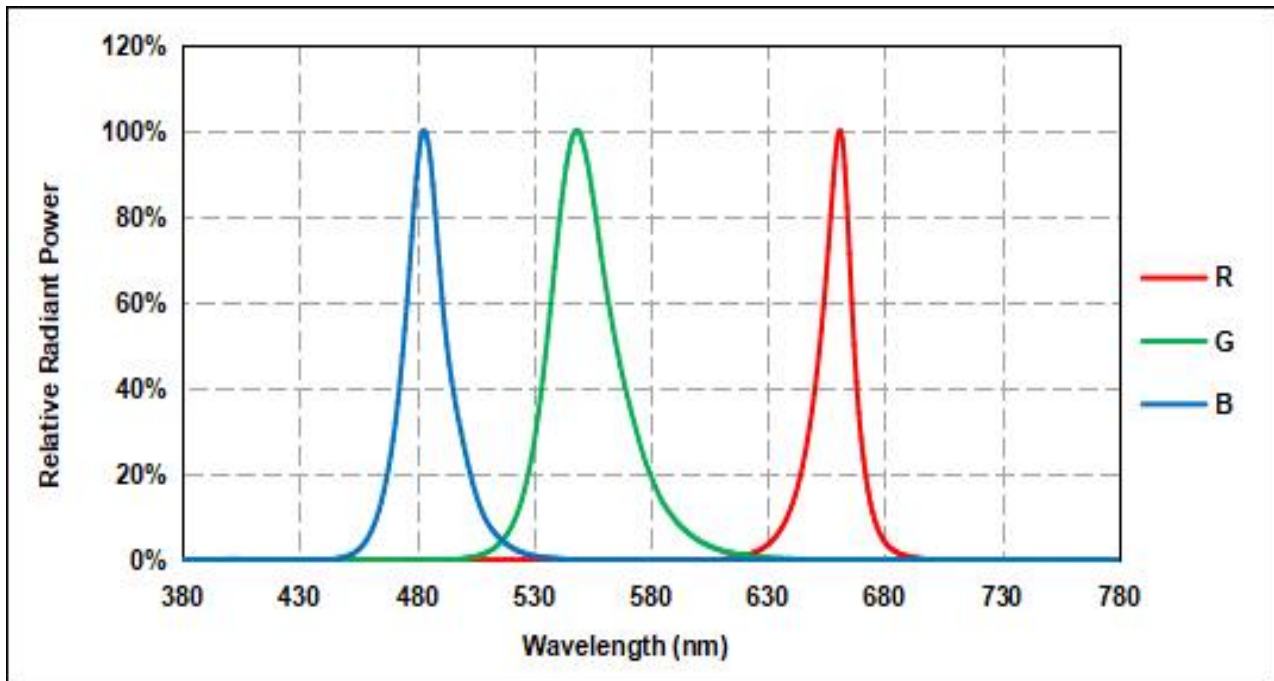

Relative Luminous Intensity VS Junction Temperature (IF=150mA, 25°C)

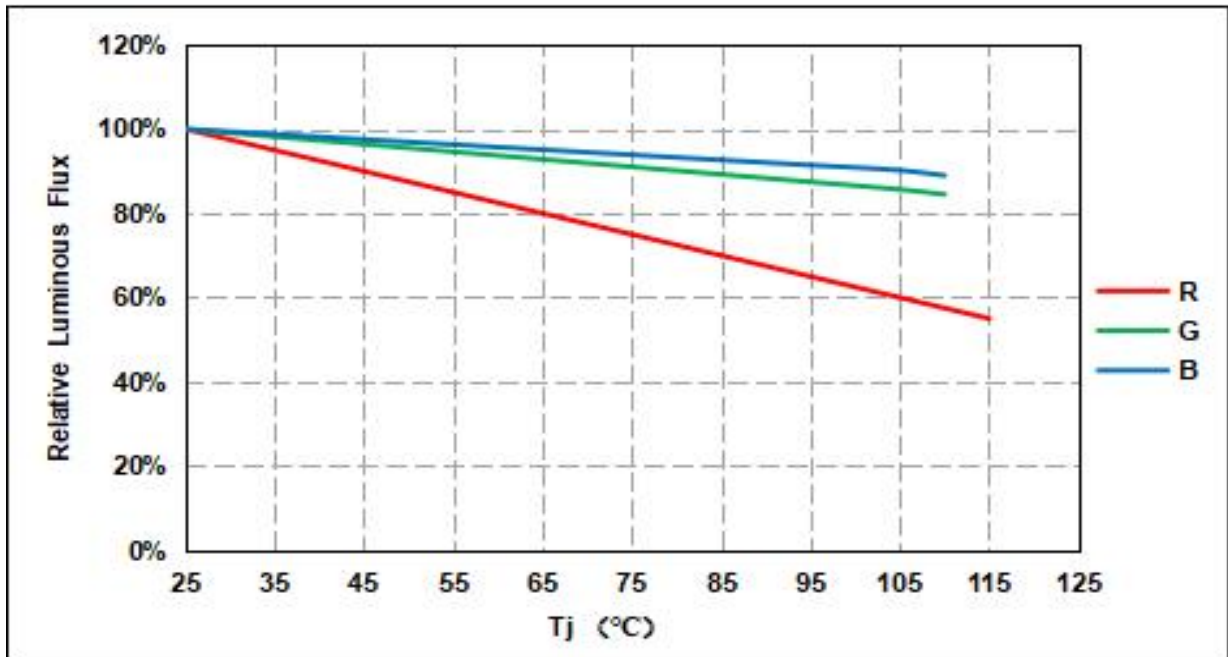

Relative Luminous Intensity VS Forward Current (IF=150mA, 25°C)

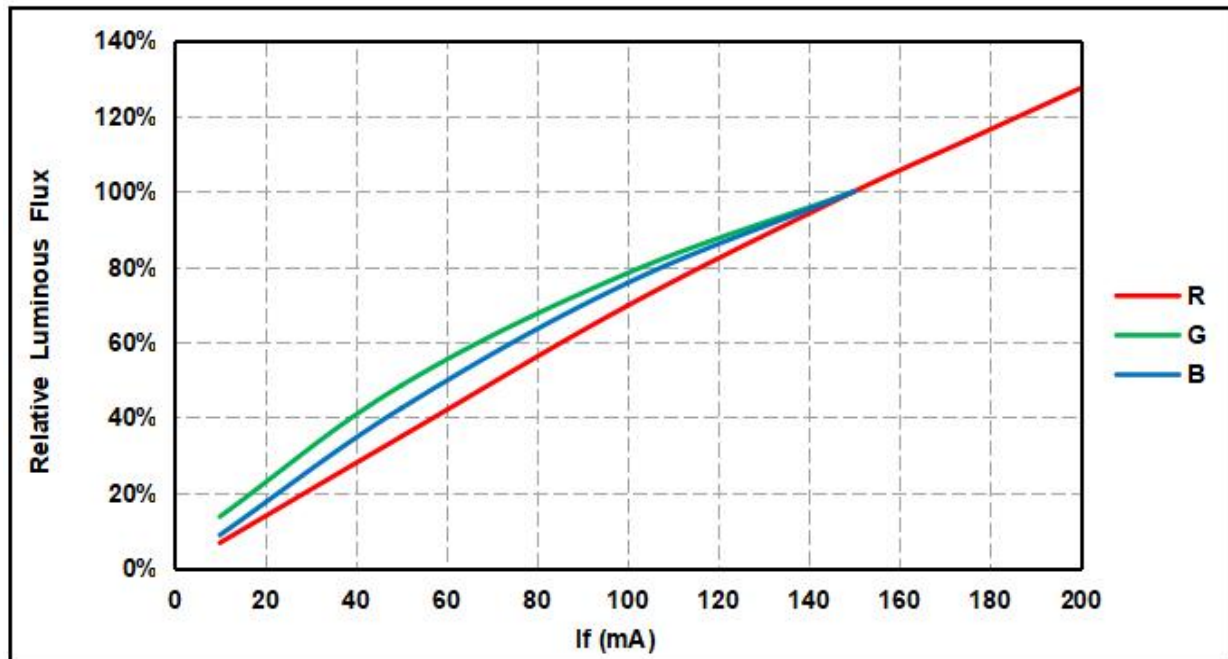

Forward Voltage VS Forward Current (IF=150mA, 25°C)

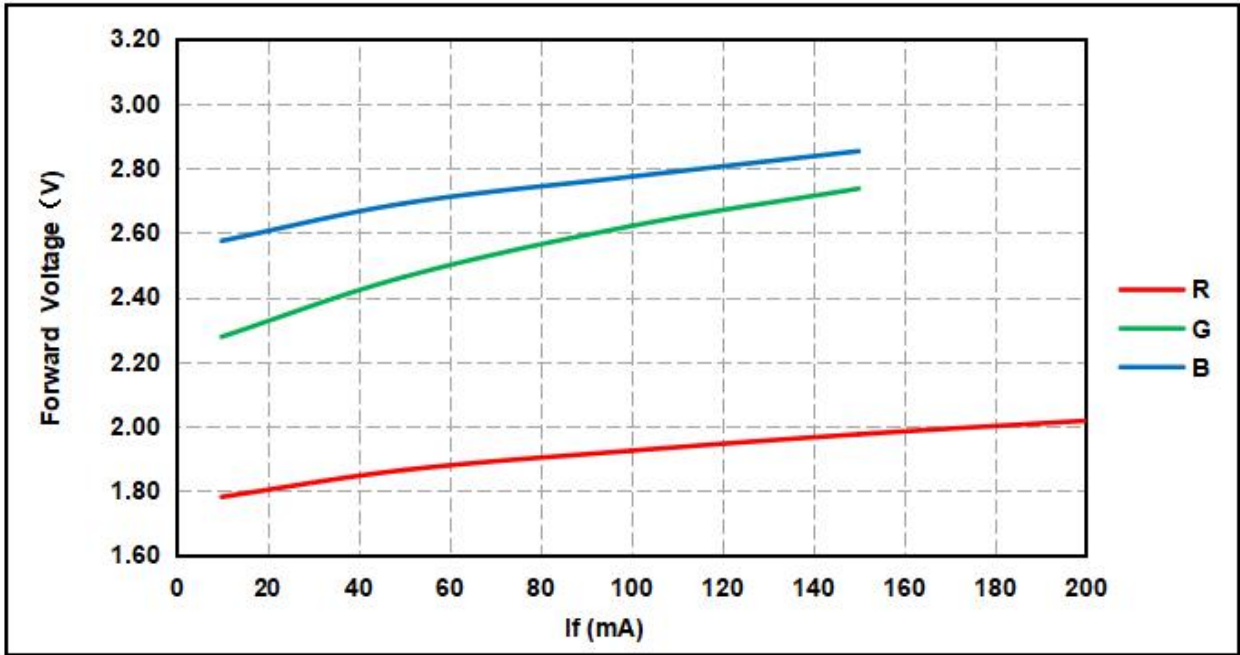

## Radiation Pattern Characteristics

Typical radiation pattern for at test current(150mA), Tj =25°

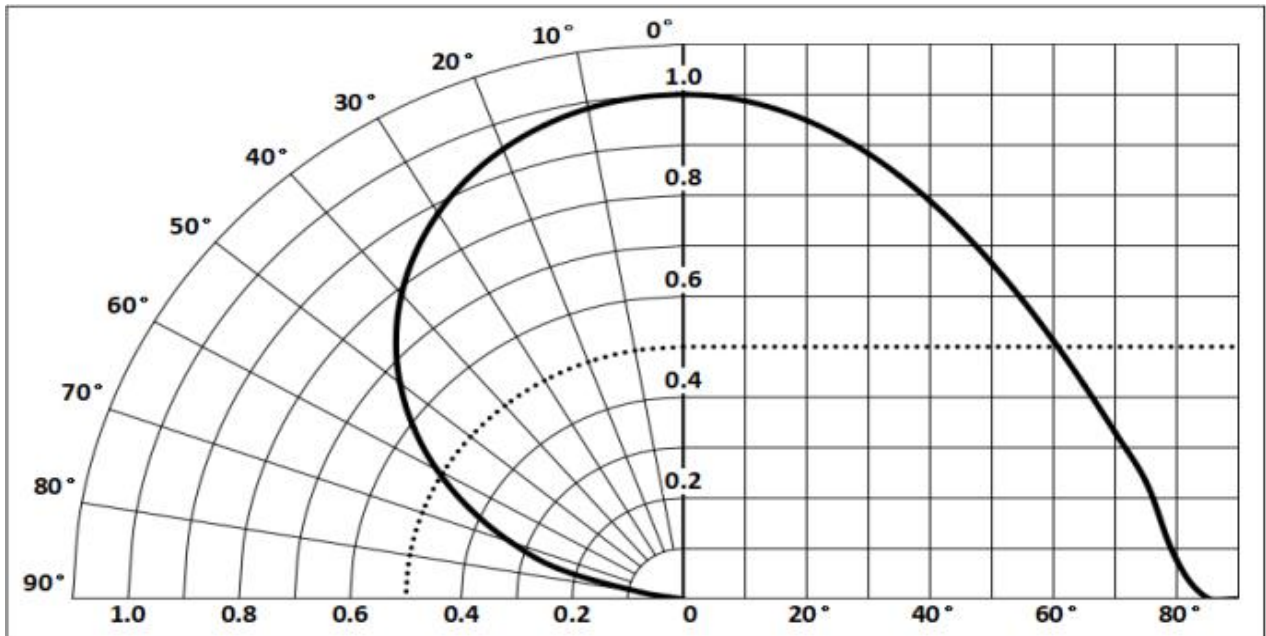



## 7、可靠性试验/Reliability Test Items And Conditions



序号 No.	试验项目 Test Item	参考标准 reference standard	试验条件 Test condition		样品数量 Sample Quantity	失效数量 Failure Quantity
1	高低温冲击 Thermal shock	JESD22-A104E	-40°C(15min) ----- +120°C(15min), ↑↓10 mins,200cycles		22pcs	0
2	高温存放 HighTemperature Storage	JESD22-A103D	+100°C, 1000h		22pcs	0
3	低温存放 Low Temperature Storage	JESD22-A119	-40°C, 1000h		22pcs	0
4	高温高湿老化High Temperature,High Humidity,Aging Test	JESD22-A101C	T=+85°C,R H=85%	IF=150MA 1000h	22pcs	0
5	高温使用寿命 High-temperature operation	IES LM80-2015	T=+105°C,	IF=150MA 1000h	22pcs	0
6	低温使用寿命 Low temperature operation	JESD22-A108D	T=-40°C,	IF=150MA 1000h	22pcs	0
7	回流焊湿度敏感实验 Moisture/Reflow Sensitivity Test	J-STD-020E	Precondition: 60°C.60%RH.168H Tsltd=260°C.10sec. 3 Reflows		22pcs	0

### 失效判定标准 Criteria For Judging Damage

项目 Test Items	测试条件 Test Condition	判定标准 Criteria For Judgement	
		Min. 最小	Max. 最大
正向电压 Forward Voltage	IF=150MA	/	U.S.L*1.1
反向电流 Reverse Current	VR=5V	/	U.S.L*2.0
光通量 Luminous Flux	IF=150MA	L.S.L*0.7	/

## 8、包装/Packaging

铝箔袋标签 Aluminum foil bag label

<b>TYF LED</b>		Natural Light for Healthy Life
TYPE : TSC-A35CM		Code : 01
P/N : TSC-A35CM-0103Z1-RGB01		02
		
L/N : 2205226	QTY : 10Pcs	
		
SPEC : R:1.0W\2.0-2.4V\350mA\620-625nm\50-60lm		
G:1.0W\2.8-3.2V\350mA\520-525nm\110-120lm		
B:1.0W\2.8-3.2V\350mA\465-470nm\30-40lm		

卷盘尺寸/Reel Dimensions (单位:毫米 Units:mm)

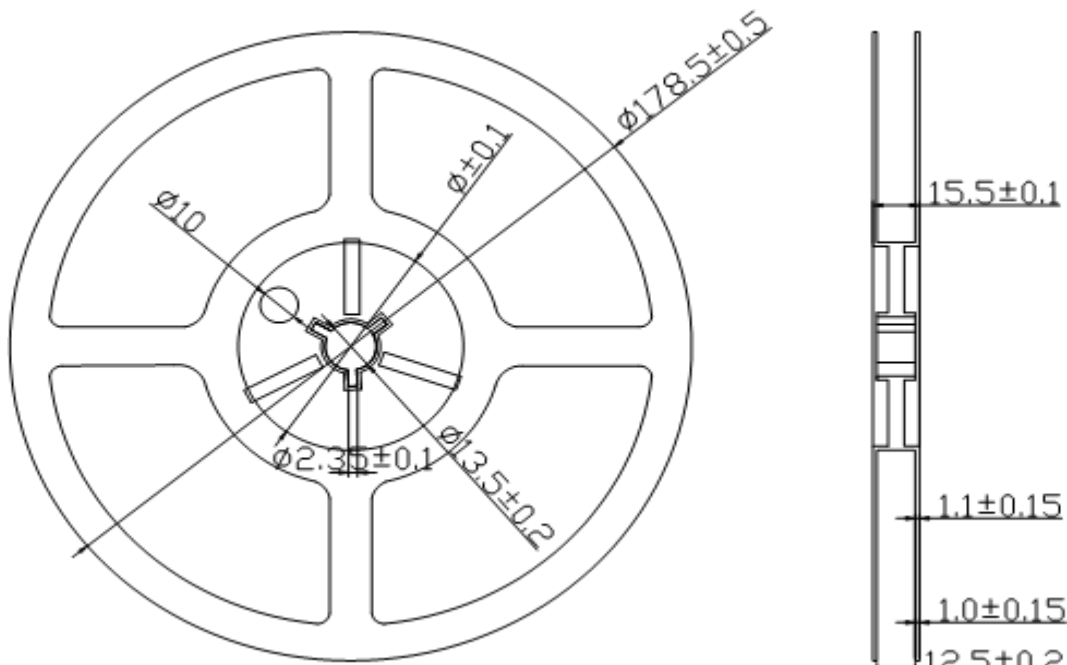

装带规格 Taping Specifications (单位:毫米 Units:mm)

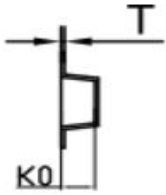
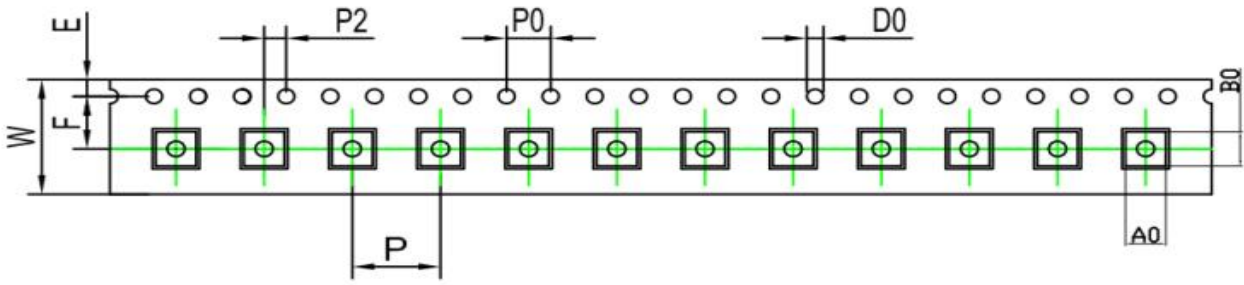

symbol	AO	BO	KO	PO	P	P2
Spec	3.90±0.1	3.90±0.1	2.48±0.1	4.00±0.10	8.0±0.1	2.00±0.10
symbol	W	T	E	F	DO	D1
Spec	12.0±0.3	0.2±0.05	1.75±0.10	5.5±0.1	1.50 <sup>+0.1</sup> <sub>-0</sub>	1.50±0.10

Moisture proof packing 防潮包装

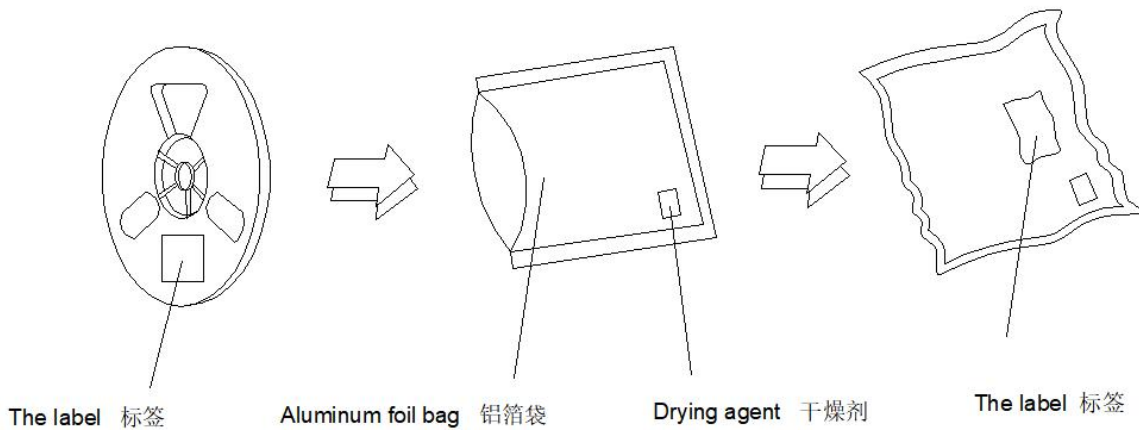

每卷数量 1000 个/卷. Package: 1000Pcs/Reel

备注 Postscript:

·LED 编带后放置在铝箔袋中真空包装，内置湿度卡，在装带之后纸箱包装；

After the LED is braided, it is placed in a vacuum package in an aluminum foil bag, with a built-in humidity card. The LED is packed in a carton after being braided.

·最小包装标签注明以下:产品名称、批号、参数范围、数量；

The label on the minimum packing unit shows ; Part Number, Lot Number, Ranking, Quantity.

·请注意防水防潮；

Keep away from water, moisture in order to protect the LEDs.

·须采取适当防护措施,以防包装箱跌落或受到强力撞击造成对产品的损伤；

The LEDs may be damaged if the boxes are dropped or receive a strong impact against them. So precautions must be taken to prevent any damage.

## 9、使用注意事项 Caution

### 1. 储藏条件 Storage conditions

打开前:温度为 5~30°C, 相对湿度低于 60%。(打开后模组应在 24H 之内使用完毕), 如未用完之产品, 请

进行除湿并抽真空后密封保存。湿度卡变色或包装袋漏气等现象必须除湿, 除湿条件: 60°C±5°C, 24H。产品密封保存有效使用期为 3 个月;

Before open: temperature is 5 ~ 30 °C, relative humidity below 60%.( the module should be used within 24H when opens), if not, please dehumidification and vacuum sealing .Humidity card changes color or bags leak must dehumidifier, dehumidifier conditions: 60°C±5°C, 24 h.The effective use period of product seal is 3 months.

### 2. 取放条件 Attention

取放及组装过程禁止挤压发光区胶体表面, 注意 SMT 贴装吸嘴选择, 防止压死灯现象;

During use and assembly, please do not press light-emitting colloid surface, pay attention to the choice of suction nozzle SMT , to prevent chip die.

### 3. 静电防护 Electrostatic protection

LED 属于 I 级静电敏感器件, 接触、使用过程做好防静电保护;

LED belong to grade I electrostatic sensitive device, please do ESD protection when touch and Use;

### 4. 清洁条件 Clean condition

LED 胶体表面脏污, 可用酒精清洗, 不可用丙酮等腐蚀性的清洗溶剂清洗;

If LED colloid surface dirt, use alcohol to clean.Can't use acetone or corrosive to clean.

### 5. 灯珠检测 The electrical test

单颗灯珠电 3V 的设置不能高于 5V, , 灯珠有正负方向, 焊反则不能正常点亮;

The setting of a single lamp bead electricity of 3V can not be higher than 5V, the lamp bead has positive and negative direction, welding can not be lit normally;

## 6.焊接条件 Welding conditions

可用加热台或回流焊机焊接。加热台焊接： $\leq 260^{\circ}\text{C}$ ，熔锡后 3-6 秒内取出，最多可焊接 2 次，自然降温到室温，方可包装。回流焊接如图：

Heating units or reflow welding machine are available to weld. Heat welding machine:  $260^{\circ}\text{C}$  or less and molten tin, 3-6 seconds after maximum welding 2 times, natural cooling to room temperature, before packing. Reflow soldering is shown in figure:

预热温度	无铅 180-200 $^{\circ}\text{C}$
预热时间	<120S 秒
峰值温度	<260 $^{\circ}\text{C}$
峰值温度焊接时间	<10 秒

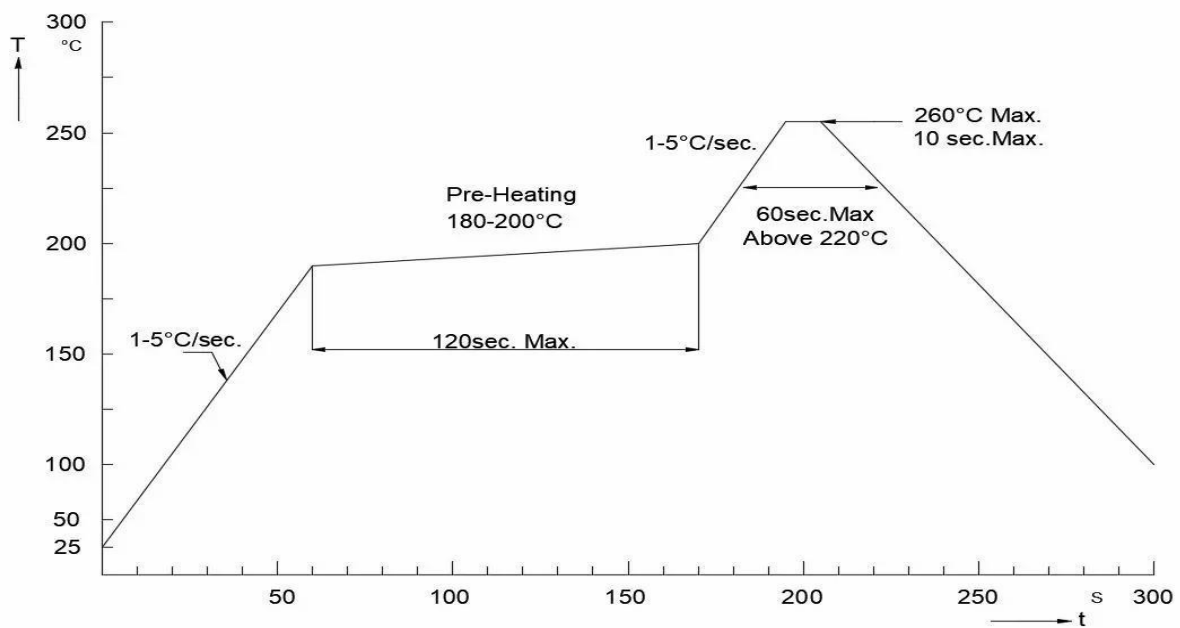

说明：最多只可回焊两次,且在首次回焊后须冷却至室温之后方可进行第二次回焊。

LEDS can be welded twice at most, it can be welded again only after the LEDES are cooled as room temperature.

## 7. 电路及散热设计 Design of circuit and heat dissipation

7.1 产品正常工作温度：TS 点（负极焊盘）小于 85°C，如果超出我司给定要求，客户必须做产品可靠性评估，风险由客户承担；

Normal operating temperature: TS point (negative pad) is less than 85 °C, if exceeded, customer needs to make reliability assessment, customer takes the risk.

7.2 电源驱动选取：本产品需使用恒流源进行驱动，且输出电流符合规格书上的功率使用范围，如需使用恒压源或其他使用条件，请进行使用效果风险评估；

Power Supply Select: This product is powered by using a constant current driver, and the output current of the power range meets the requirement of specifications book, if use constant voltage source or other conditions, please do risk assessment.

## 8. 使用环境要求 Environmental requirements

此产品设计不针对下列任何条件，如在下列任何条件下使用产品，请确定其正常性能和可靠性；

如：潮湿，有露水凝霜，盐水空气，腐蚀性气体的地方（CL, H<sub>2</sub>S, NH<sub>3</sub>, SO<sub>2</sub>, NO<sub>x</sub>, 等）；太阳直晒下，户外

暴露，多灰尘的地方。水中，油，医用液体和有机溶剂等；

This product can not use under below situations, if use the product in any of the below conditions, please make sure the performance and reliability; Such as: wet, frost, salt air, corrosive gases (Cl, H<sub>2</sub>S, where NH<sub>3</sub>, SO<sub>2</sub>, NO<sub>x</sub>); Exposure under the sun, exposure outdoor, dusty. Water, oil, liquid medical and organic solvent.

## 9. 使用兼容性 Using Compatibility

9.1 灯具中气体的化学成分以及光源周围的环境对灯具的寿命至关重要，特别是当您选择在灯具设计中使用化学成分时尤为重要。考虑使用任何材料之前，务必先咨询产品供应商或 LED 制造商。使用某种材料前获取的信息越多，灯具寿命期内的性能越高；

The chemical composition of gas in lamps and surrounding environment of light source are essential to the life of the lamps, especially when you choose to use chemical composition, it is particularly important in lighting design. Before considering the use of any material, be sure to consult the product supplier or LED manufacturer. The more information obtained before using some material, the higher the performance of the lamp.

9.2 产品色差问题 Color difference matters needing attention

不同 BIN 的 LED 光电参数有差异，使用前，须仔细评估；

The different Bin led has different photoelectric data, before use, please assess carefully.

9.3 具体使用注意事项参考《SMD 产品使用注意事项》；

Specific please check the <<Precautions for using SMD products>> for reference